

PLAN VIEW

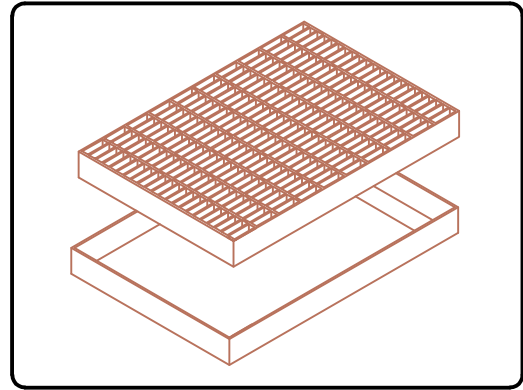

Traffic Frame & Grate are specified per Caltrans standard details D77A or D77B

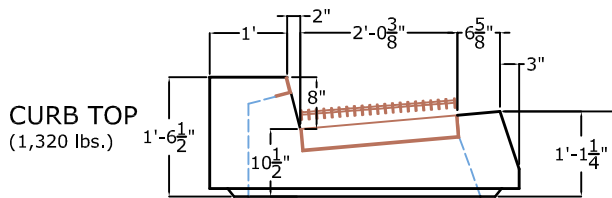

RISER (1,050 lbs./ft.)

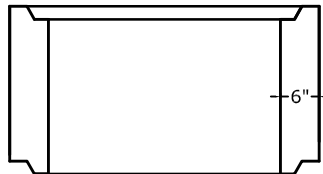

Oversized Holes cast in

Sloped Floor must be casted in the field

BASE (1,200 lbs. + 1,050 lbs./ft.)

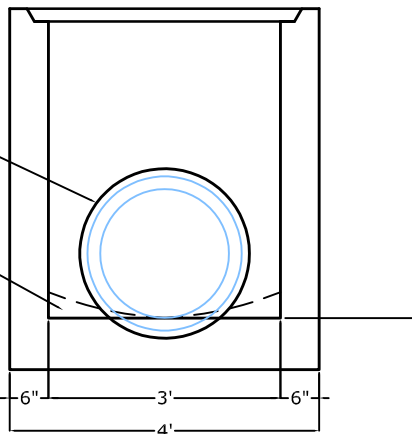

SECTION A-A

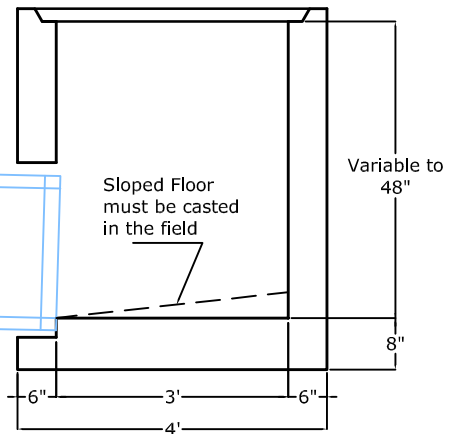
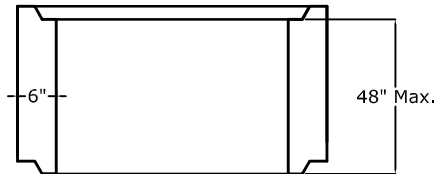
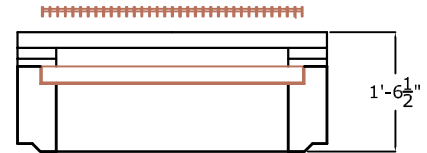

SECTION B-B

NOTES:

1. GO structure in compliance with 2010 Revised Standard Plan RSP D73E.
2. Wall thickness is 6" when the distance between the outlet flow line and the top of grate is 8' or less.
3. Holes are cast in per plans requirements.
4. Integral base includes 8" flat floor. No slopes provided. Sloped floor must be cast in the field.
5. Steps installed.



1625 E. DONOVAN RD., STE. C
SANTA MARIA, CA 93454
PH: (805) 928-2855
FAX: (805) 928-2114
www.midstateconcrete.com

GO CURB INLET
Cal Trans Standard