

TOP VIEW

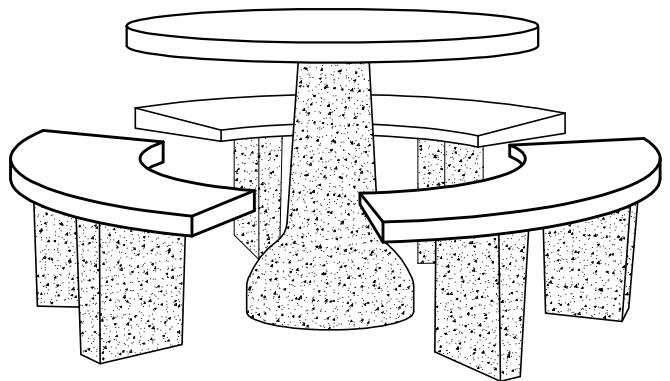

ISOMETRIC

Wt: 1,125 lbs.

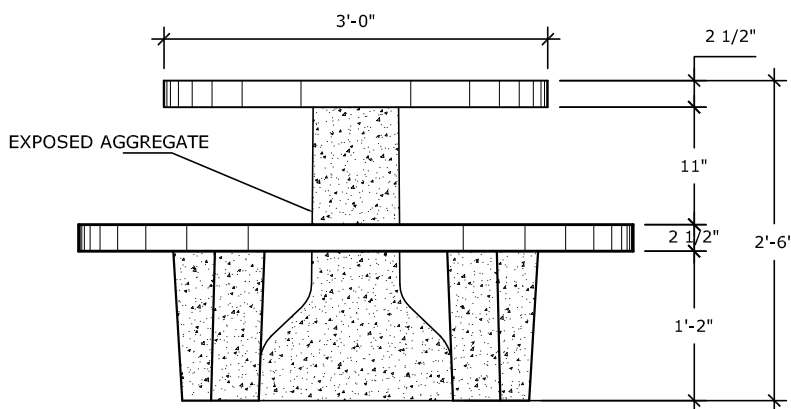

FRONT VIEW



1625 E. DONOVAN RD., STE. C
 SANTA MARIA, CA 93454
 PH: (805) 928-2855
 FAX: (805) 928-2114
 www.midstateconcrete.com

**0036 CIMARRON TABLE
 AND BENCH SET
 PRECAST CONCRETE**

REV. 09/07